

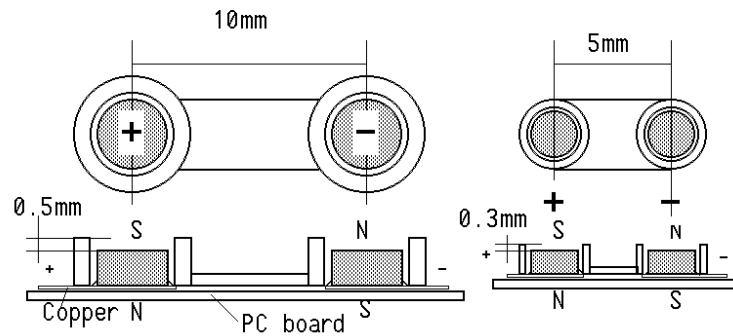

## Battery Holder using Magnets (BaHoMa system) 2019 redesign

Clearly, it is not convenient to connect a LiPo on a micro drone et helicopter.  
Same for a small robot or wearable that take advantage of today's technology.

The problem was worse in 2004 with the first ultralight indoor planes. We developed the Bahoma system with 5 and 10mm magnet spacing. Handling a switch and a connector is too aggressive on a 5 grams and less plane.

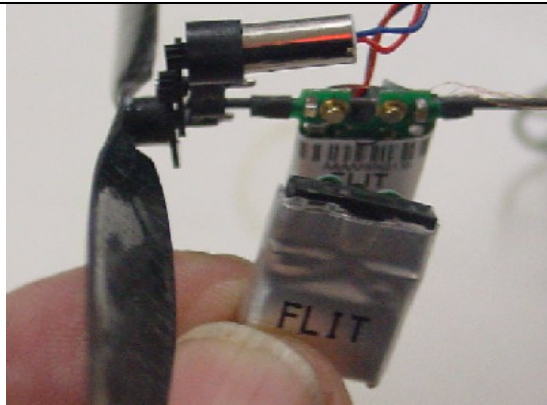
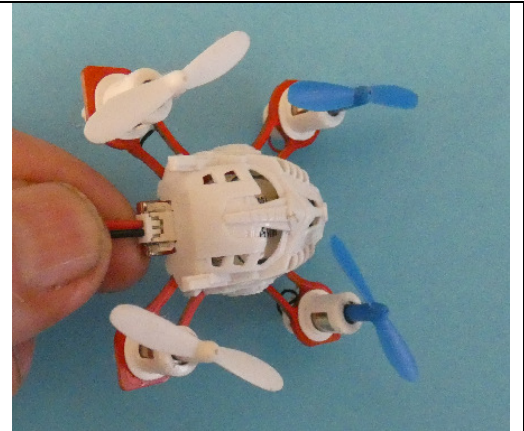

More on <https://www.didel.com/slow/magnets/Bahoma.pdf>

### New Bahoma standard

We dropped the 5mm standard and are fully compatible with the 10mm.

### Products

Didel propose only one 110 mAh Lipo. Size and capacity correspond well to Didel boards. Capacity is not the important parameter with Bahoma; the Lipo is replaced by a new one in a snap; it is easy to demonstrate a robot for a full day at an exhibition.

The LiPo internal resistance is very low and current can be the 300 mA required by a small ESP32 with active WIFI. This leave 20 or 30 minutes before changing the LiPo. If you need hours, the Lipo is surely not the solution.

**Bali110** 110mAh  
20x12x3mm  
2.2x2.3mm magnets,  
force against similar  
magnet: 300 g



Of course you also have special needs, or you wish to convert you Lipos with all kinds of connectors as Bahoma Lipos. They just will not be as nice and compact as the Bali110.

## Bahoma on existing LiPos

What is convenient is to have the connector glued to the LiPo. We did experiment with different LiPos.

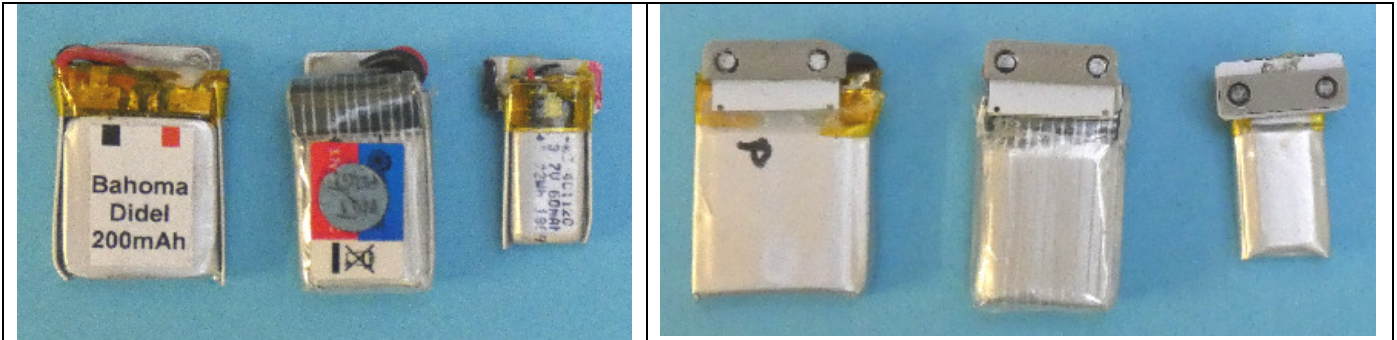

We propose the **Balada** piece if the Lipo wire is flexible.

See how to position at best, cut the wires, solder.  
Remove the protection film locally so the glue have a contact area.

Use a **Bapow** if strong wires and finish as you can.

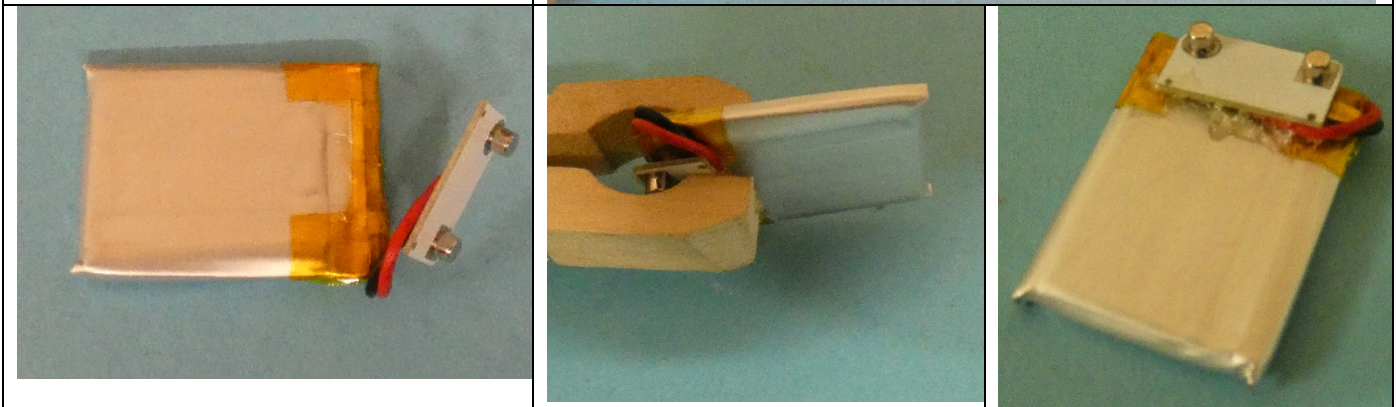
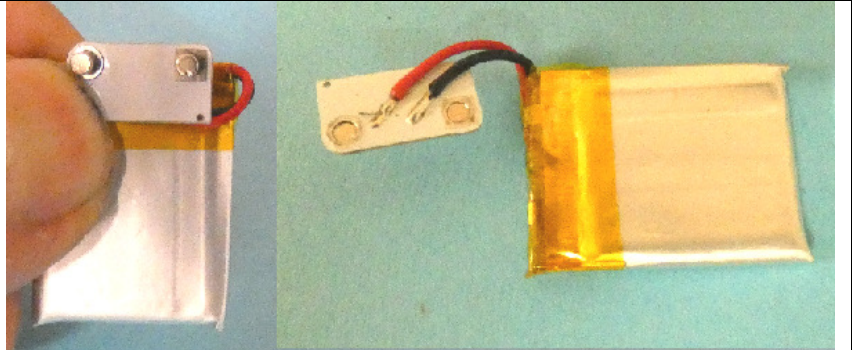

If you accept the Lipo hanging on a connector, use the **Bapow** (power source) part. On existing devices, use the **Dadev** part. Both have the magnets correctly set, connect with red and black wires.

Bahoma power source connector (on batteries, DC powers)

**Bapow**

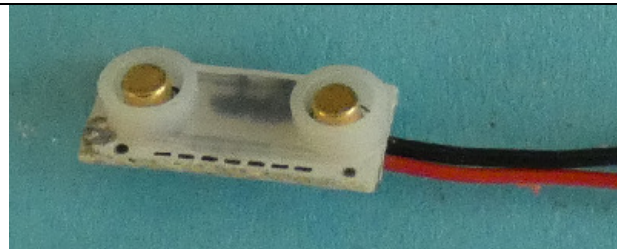

On existing equipments we have similar pieces with the good magnet polarity.

Bahoma device connector

**Badev**

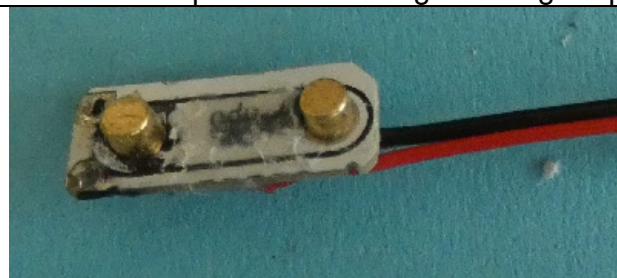

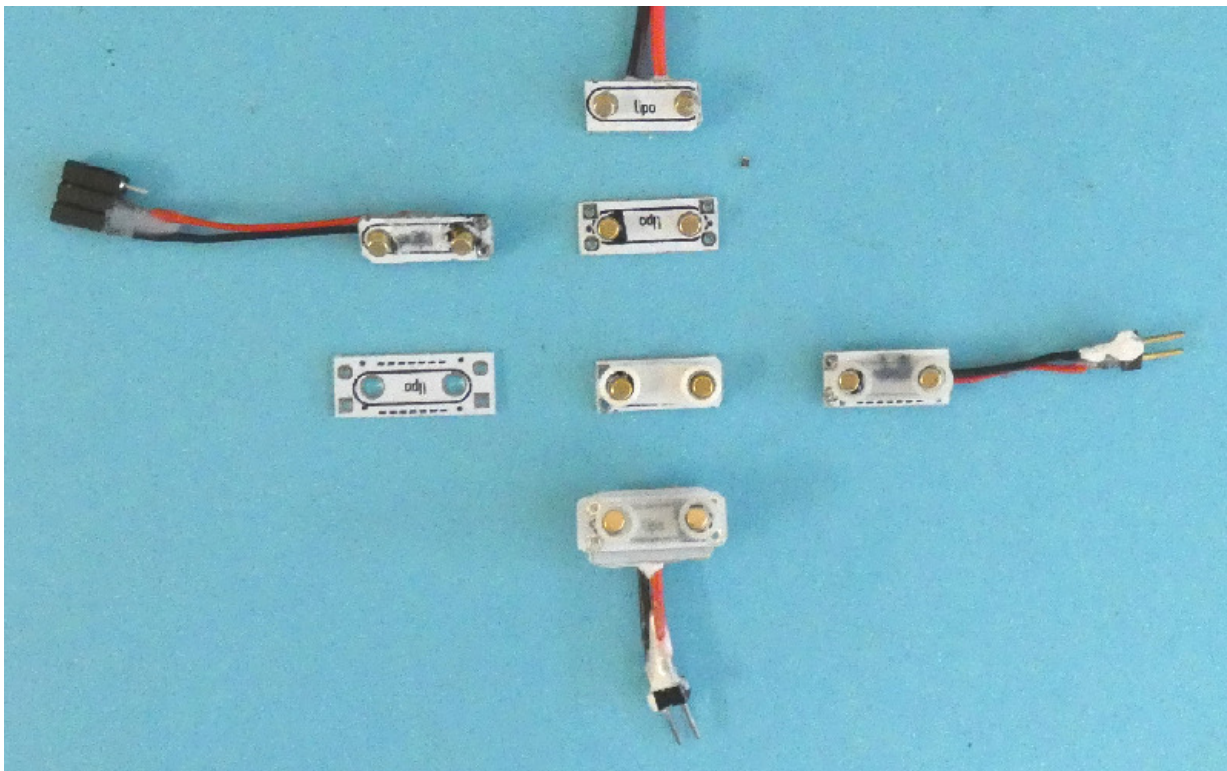

**Notes:**

- 1) As preproduction we experiment different shapes and magnet sizes dia 2, 2,2 and 2.5mm. We set for 2.2 mm for Bahoma Lipos and "dui" cards.
- 2) What you may consider as a weak point is magnets must be clean. They attract metallic dust. Use a Qtips and for sizable objects a non magnetic tweezer.

**Why not soldering magnets?**

No problem, you just need higher temperature magnets and lower temp solder. Press insert just needs precise diameter difference: 0.15 to 0.1mm is our choice with 0.6mm PCB.  
 In case you did not get the good hole diameters and the magnets are loose, it is possible to put small drops of solder on the bottom circle of the magnet, with the other side of the magnet stucked on a metal piece. 20% of the force may be lost, but it still will be usable.

**Protecting the LiPo against shorts**

Care must be taken to avoid shorts. LiPos have a protection circuit and can stay shorted for a long time. A mechanical protection is preferred, and make a visual difference between the Power sources and Device. 2006 Lipos were not protected, a short was producing heat and ballooning of the LiPoo, like for a complete discharge. Up to 250mAh, there is no danger. Above, you risk the worse !

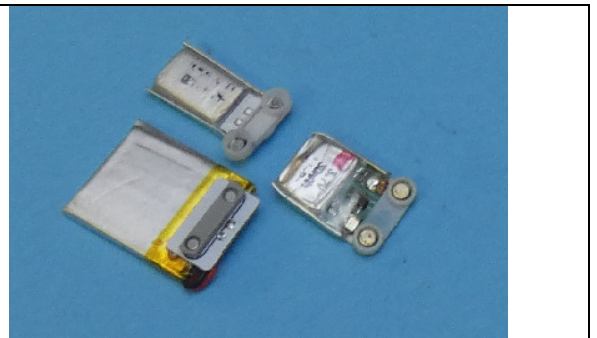

**Charging and testing a Bahoma battery**

Soldering a **Badev** connector on any charger, you can charge the Bahoma LiPos. Didel has for years the LipoCha, and LipoTest; a new circuit combine both: [www.didel.com/LipoCha](http://www.didel.com/LipoCha)  
 A new combined charger and tester is under development.



## Applications

The **Brio engine** of the picture is powered by a single AAA cell, difficult to change. With Bahoma, the loco is moving two times faster. Kids enjoy!

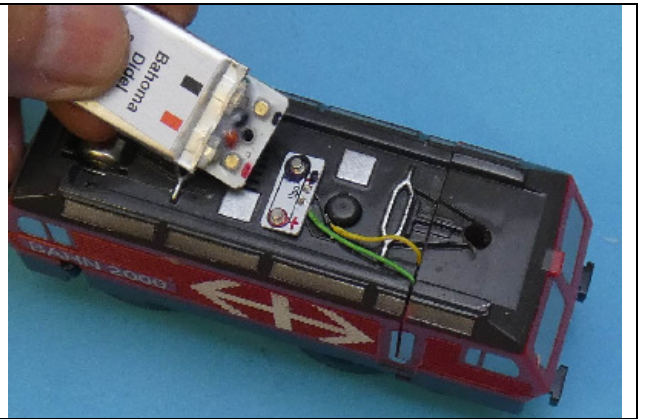

The Didel **Turtle** worked fine when the NiMh 40mAh was fully charged. After 5-10 minutes, the internal resistance was creating a resetting voltage drop. No problem with Bahoma, one hour non stop.

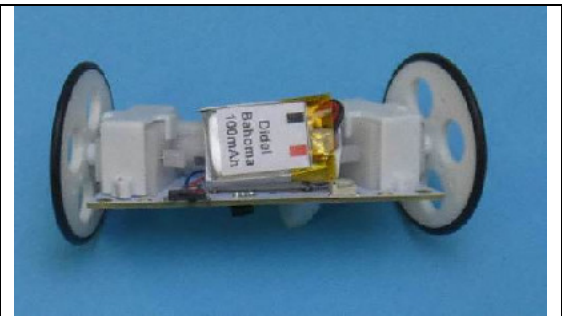
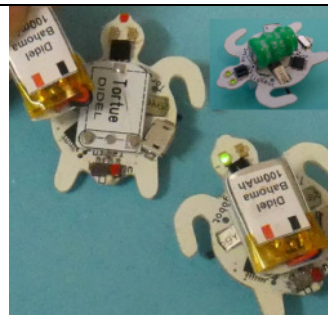

That magnifying glass used two LR44 cells. Replacing with a LiPo brings more light and saves the LR44.

