

Idées de projets TM 130907

-- Ceci a été fait en vitesse et j'aimerais mieux l'expliquer et compléter. Des liens ont été perdus et je dois les retrouver. Vous avez peut-être aussi des idées, des liens intéressants à me communiquer → nicoud@didel.com



Useless Box Principle of Operation

The circuit is quite straight-forward. Follow along this schematic description:

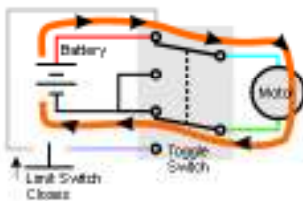

Motor is toggled on, turning clockwise, moving the arm to the switch.

When the arm starts extending, the limit switch inside closes.

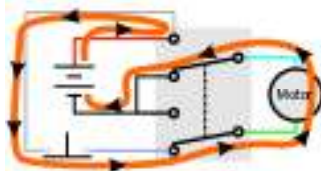

CLICK!

The motor successfully toggles the switch, and the power reversed direction.

The arm starts retracting back into the box.

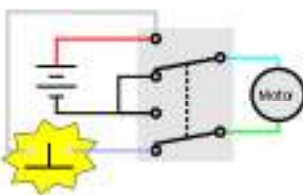

BUM!

Fully retracted, the limit switch is pushed down, disconnecting power from the motor.

Now it's ready for another cycle!



<http://9x20lathe.blogspot.ch/2010/01/components-and-schematic-for-useless.html>

Robot sans électronique

<http://www.robot-maker.com/index.php?/topic/8912-4-livres-de-frederic-giamarchi-thomas-duval/>

www.didel.com/AtRobotSimple.pdf

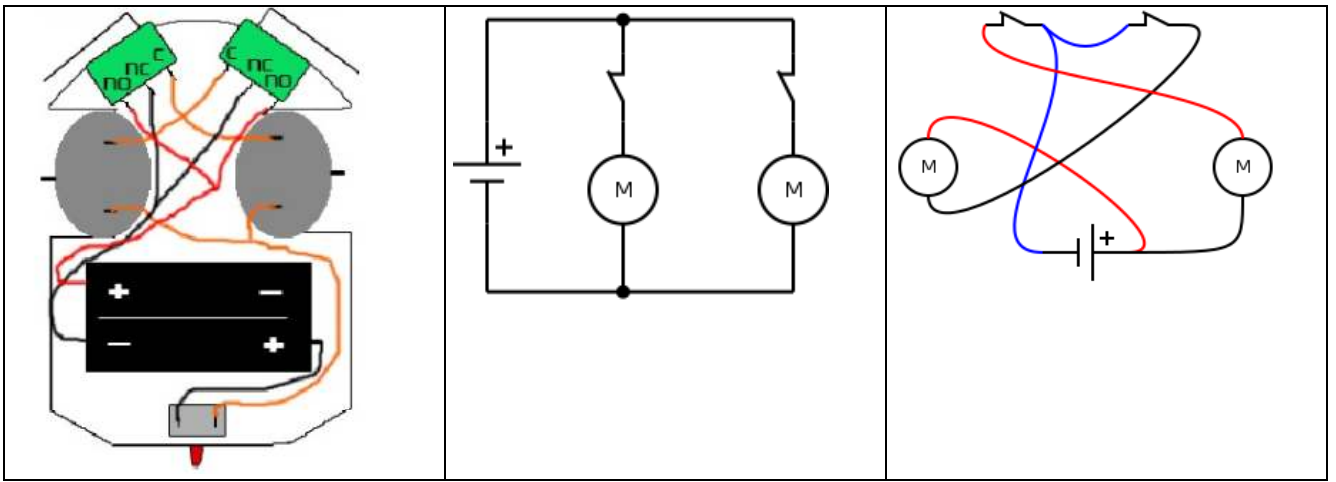

Moteur homopolaire

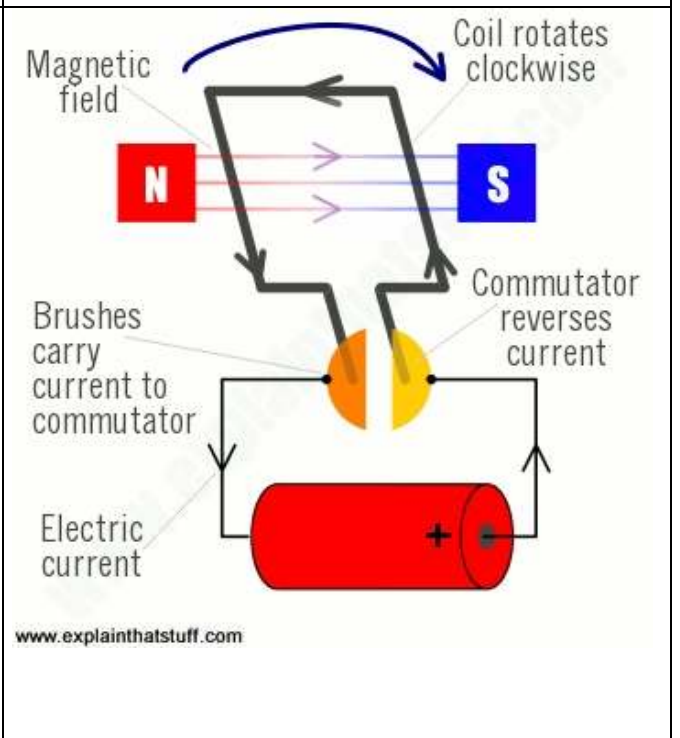
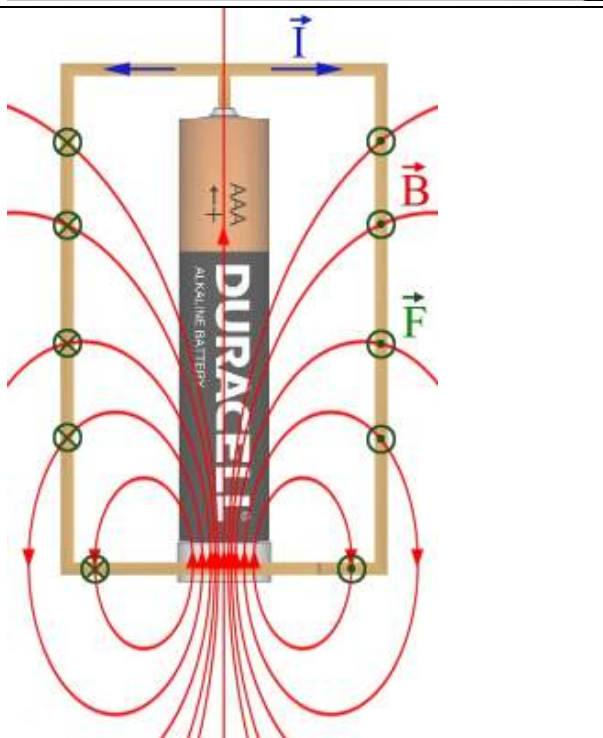
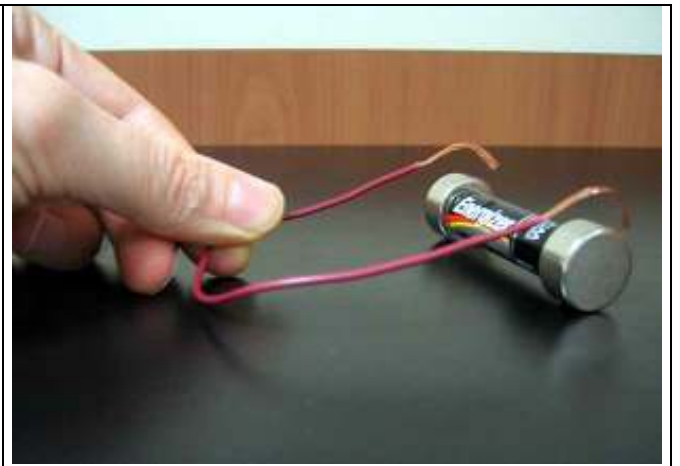
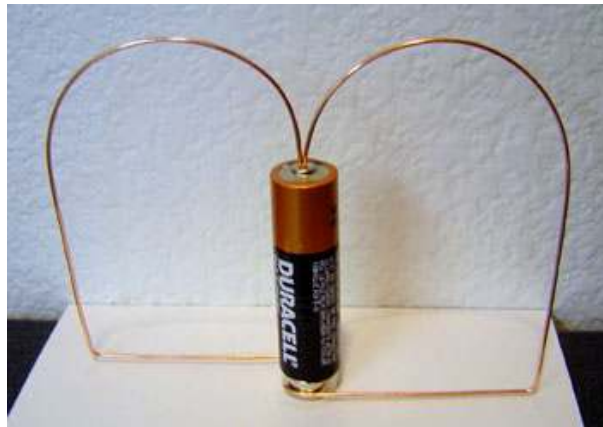

Chercher "homopolaire" sur le net

Binary marble adding machine



Le site de Pascal Peitrequin
<http://www.expo-robots.net/>

Pascal vient volontiers dans les écoles



"Miaou"

www.bricobot.ch/kits/Miaou.pdf

Le Natel s'allume, la résistance d'une LDR diminue et déclenche une action.

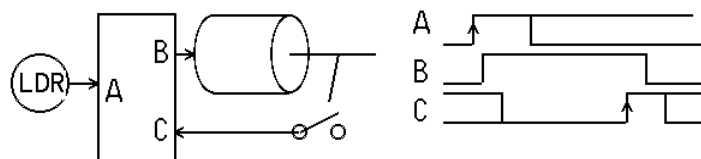

L'organigramme se transpose en schéma électronique, logique, avec processeur programmé en Basic, ou autre.

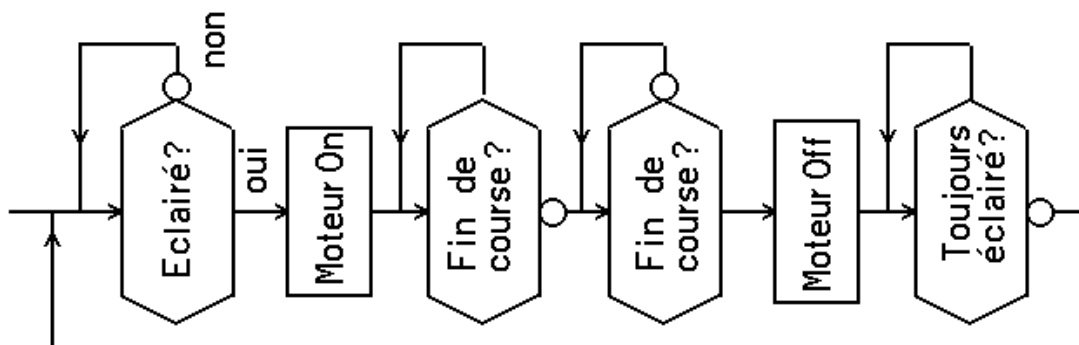

Illuminer un œuf

www.bricobot.ch/docs/Oeufs.pdf



Moteur vibrant

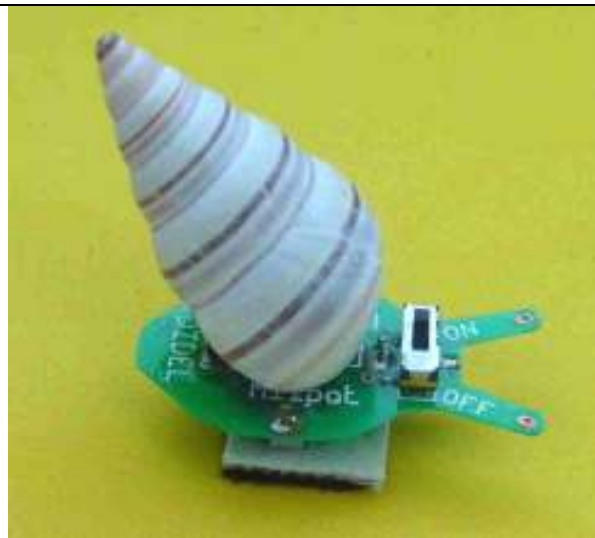
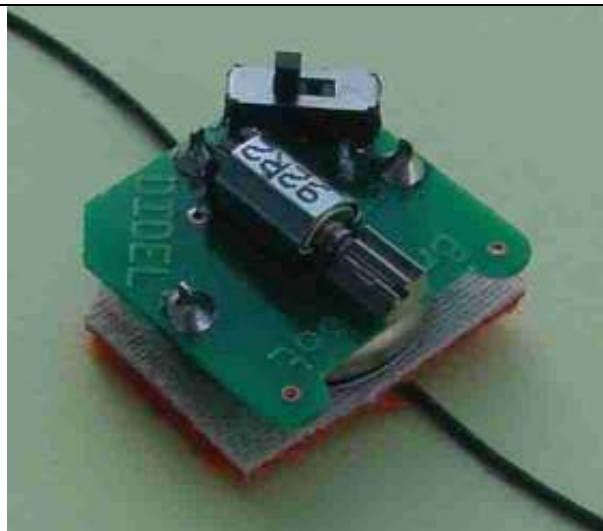

<http://www.youtube.com/watch?v=4J9HDG60x-k>

chercher "bristlebot"

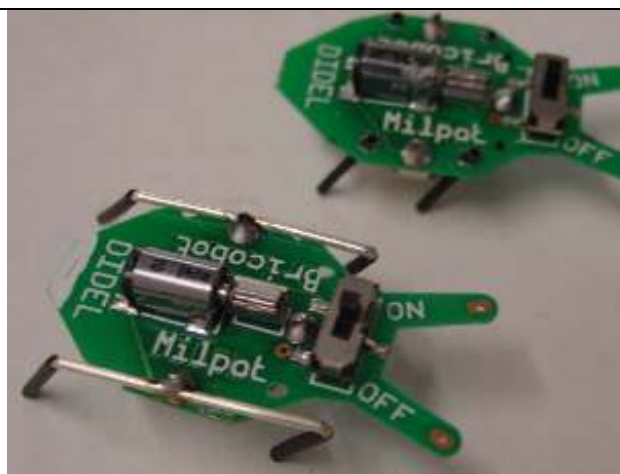

HexBug Nano (Festival 2002)

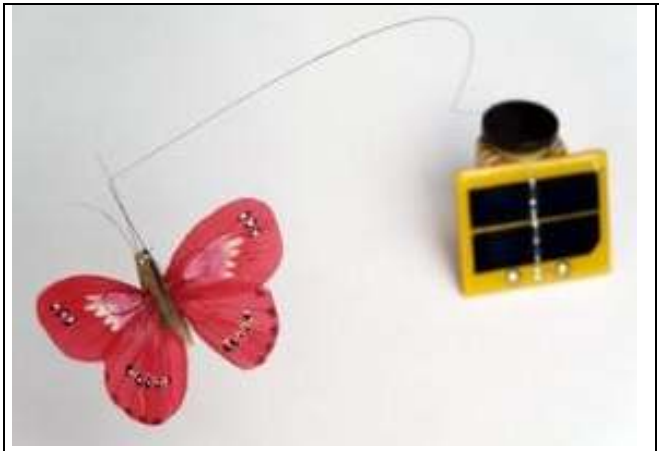

Forest Xylophone Plays Bach

<http://www.youtube.com/watch?v=L2BWrmNhyXU>

Incredible machine

<http://www.youtube.com/watch?v=wQGn4wTIFs4>

Theo Jansen

<http://www.youtube.com/watch?v=pCtA5kX-Ktg>

Levitation

<http://www.grand-illusions.com>



Manque logique hydr